



Bord/Bænk

301011/301012

Montageanvisning • Assembly instructions • Montageanleitung
Instructions de montage • Instrucciones de montaje

Please be advised to only use manual tools for assembly!

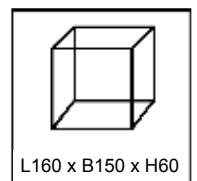
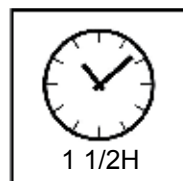
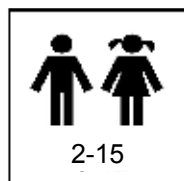
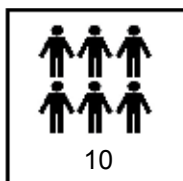
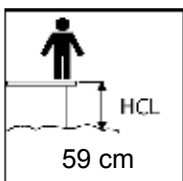
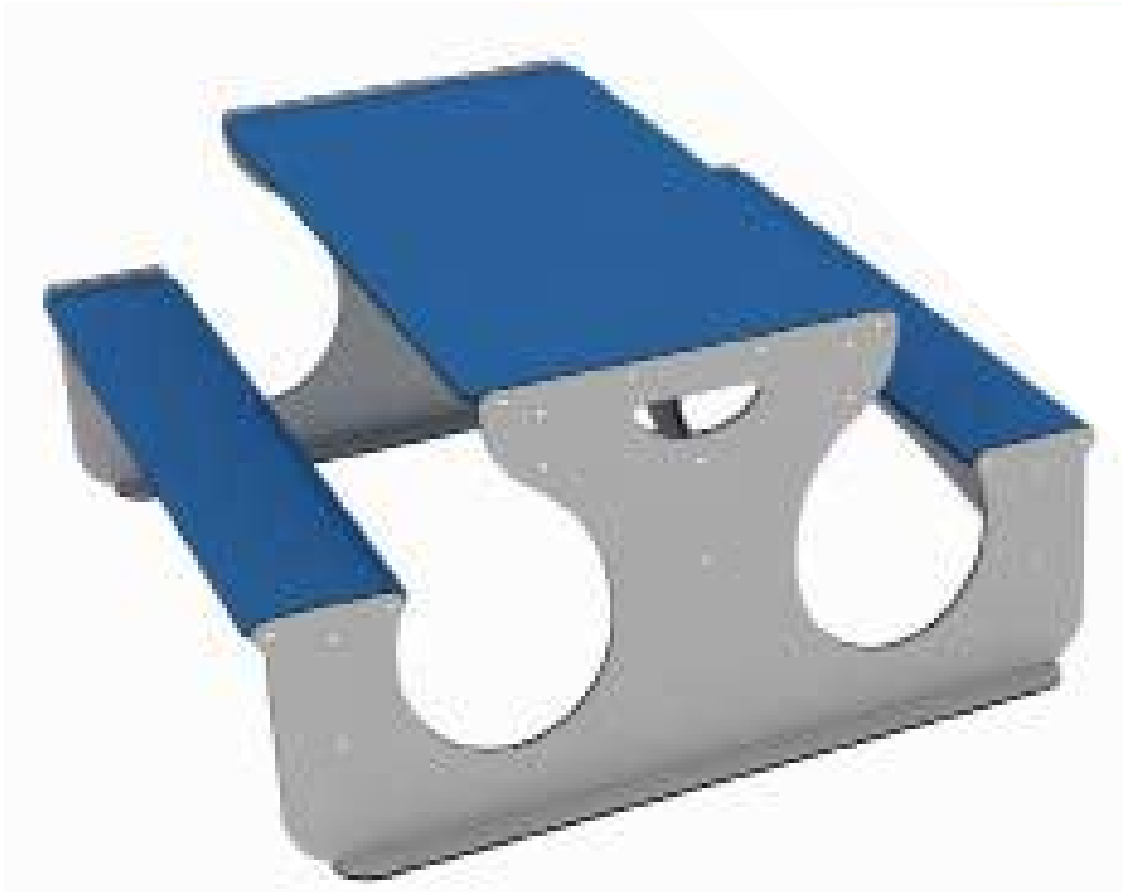

Gode råd og vink

- DK**
1. Tag komponenterne af pallen og læg dem på jorden
 2. Check efter komponentlisten om alle er med
 3. Vær omhyggelig med afstande generelt
 4. Pak én komponent ud af gangen og gør denne færdig
 5. Vær omhyggelig med brug af vatterpas
 6. Faldunderlag etableres til allersidst sammen med påsætning af mærkning med producent

GB **Some good advice and tips**

1. Take all components from the pallet and place them on the ground
2. Compare with components list – is everything there?
3. Be at all times precise when measuring
4. Unpack one component at a time and assemble it
5. Usage of a water-level will increase precision
6. Fall protection is the very last thing to be installed – along with the producer's label

DE **Ein paar gute Ratschläge und Tipps**

1. Alle Bauteile von der Palette nehmen und auf den Boden legen.
2. Anhand der Bauteileliste überprüfen, ob alle Teile vorhanden sind
3. Beim Abmessen generell präzise arbeiten
4. Ein Bauteil nach dem anderen auspacken und montieren
5. Die Benutzung einer Wasserwaage erleichtert die Montage
6. Die Fallschutzunterlage wird erst ganz zum Schluss verlegt – dann, wenn das Produzentenetikett angebracht wird

FR **Quelques bons conseils et astuces**

1. Prendre tous les composants de la palette et les positionner sur le sol
2. Comparer avec la liste des composants - avons-nous tous les éléments ?
3. Toutes les mesures doivent être effectuées avec précision
4. Déballez un élément à la fois et assemblez le
5. L'utilisation d'un niveau à eau améliore la précision du montage
6. Le sol de réception est la dernière chose à installer selon les prescriptions requises par le fabricant

ES **Ein paar gute Ratschläge und Tipps**

1. Tome todos los componentes de la plataforma y colocarlos en el suelo
2. Comparar con la lista de componentes – ¿esta todo?
3. Sea preciso con las medidas y en medir.
4. Desembalar ún componente a la vez y monta lo
5. El uso de un nivel es necesario. Si no se complica la vida en montar lo ultimo.
6. Losetas/ Goma el la zona de caída es lo último que se instalen - junto con la platina del fabricante.

Pladshensyn • Clearance • Platzbedarf • Sécurité et sol • Liquidación

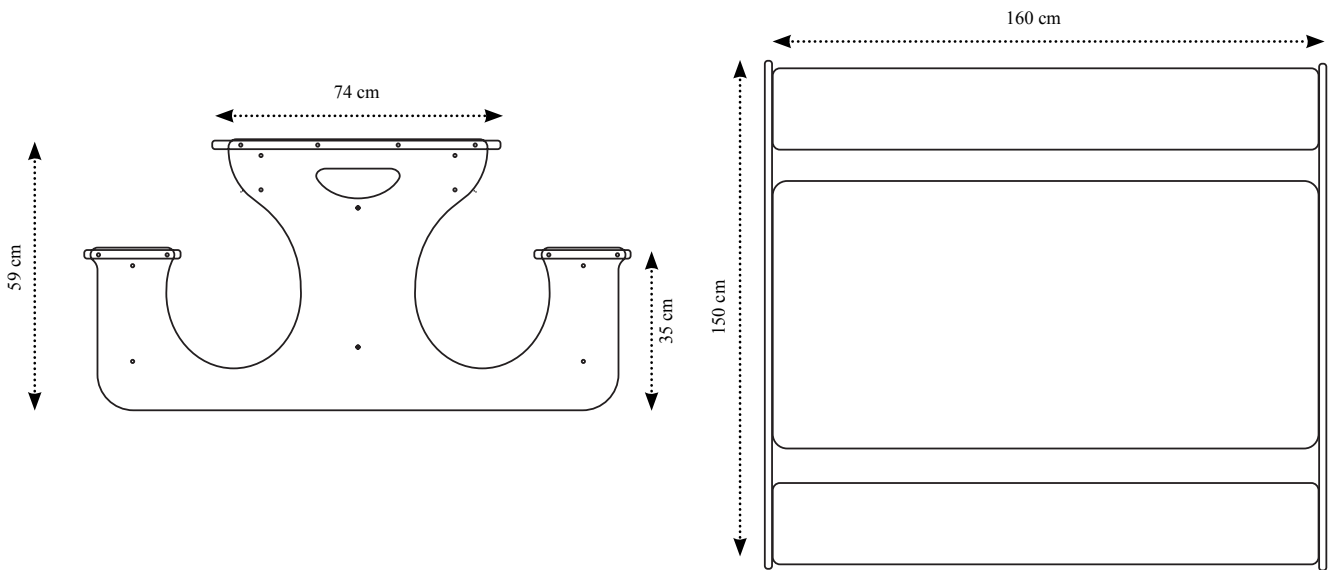

Komponentorientering • Components overview • Bauteileübersicht
Liste des composants • Lista de componentes



Montage 1 • Assembly 1 • Montage 1 • Assemblage 1 • Asamblaje 1

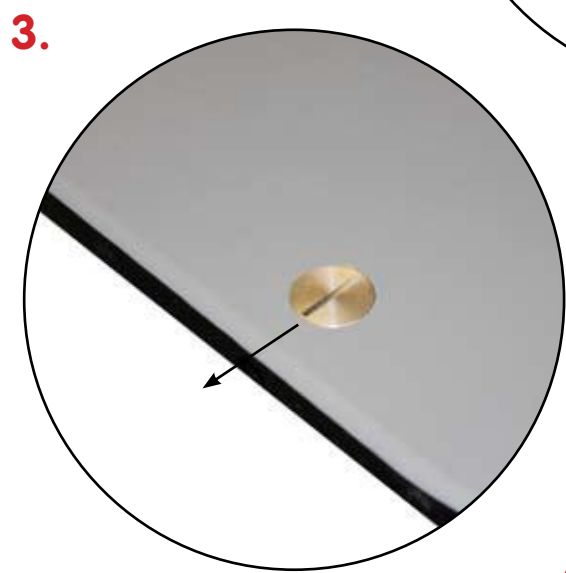
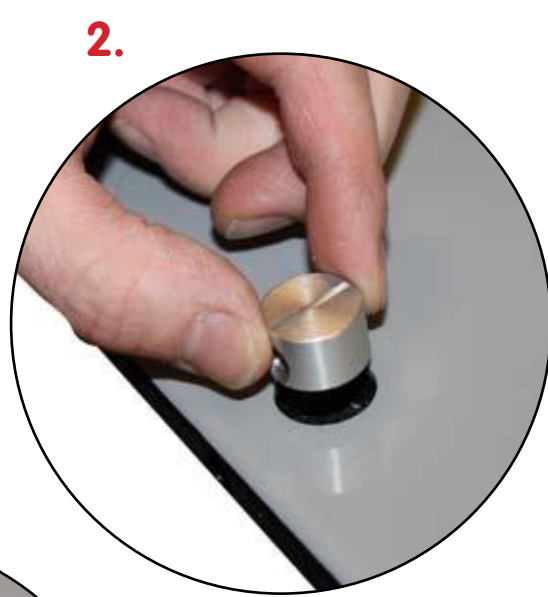
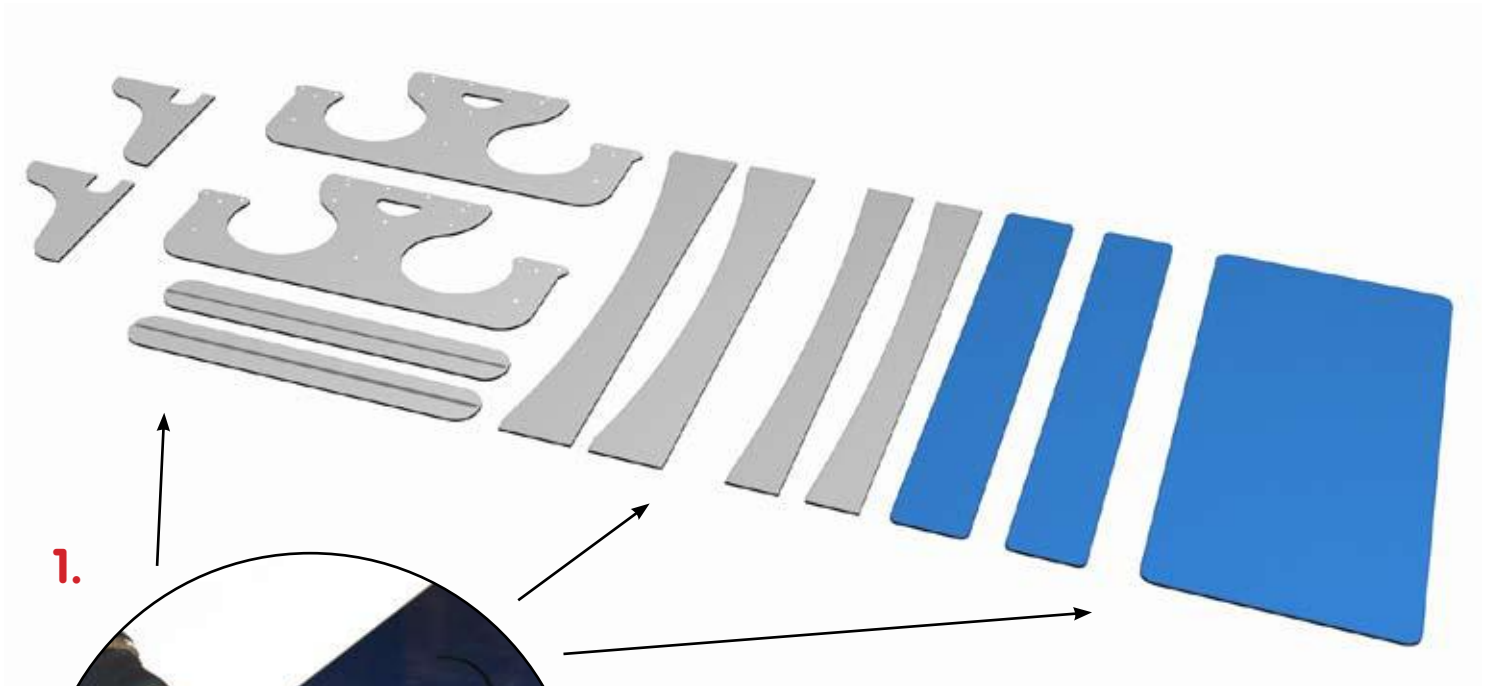

4

Montage 2 • Assembly 2 • Montage 2 • Assemblage 2 • Asamblaje 2

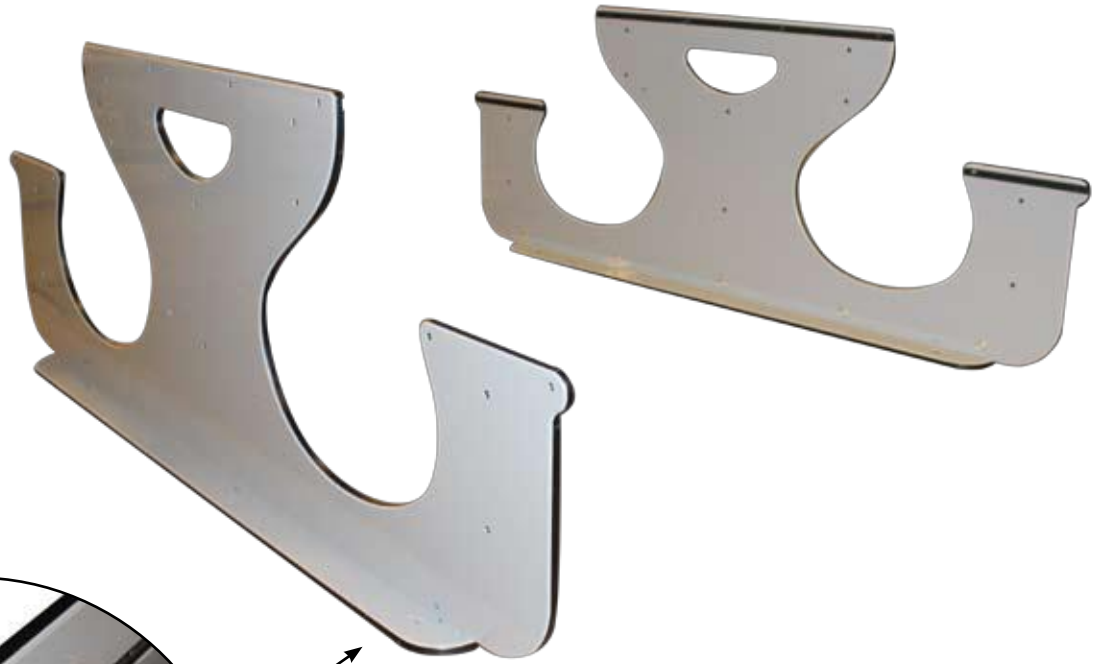

4.



5.

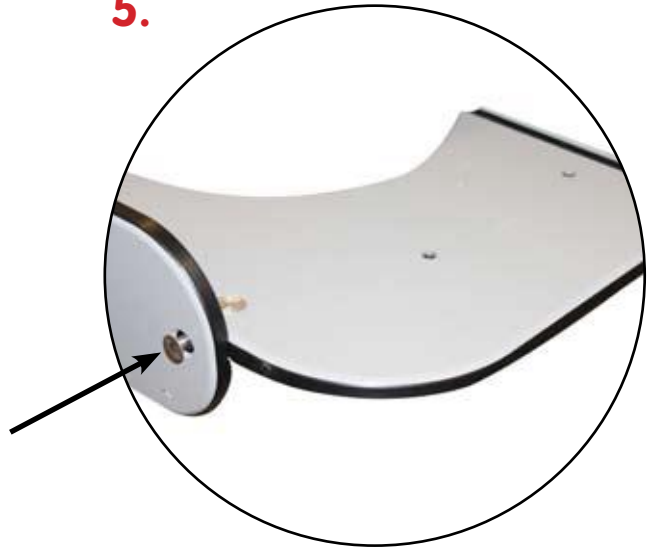

Montage 3 • Assembly 3 • Montage 3 • Assemblage 3 • Asamblaje 3

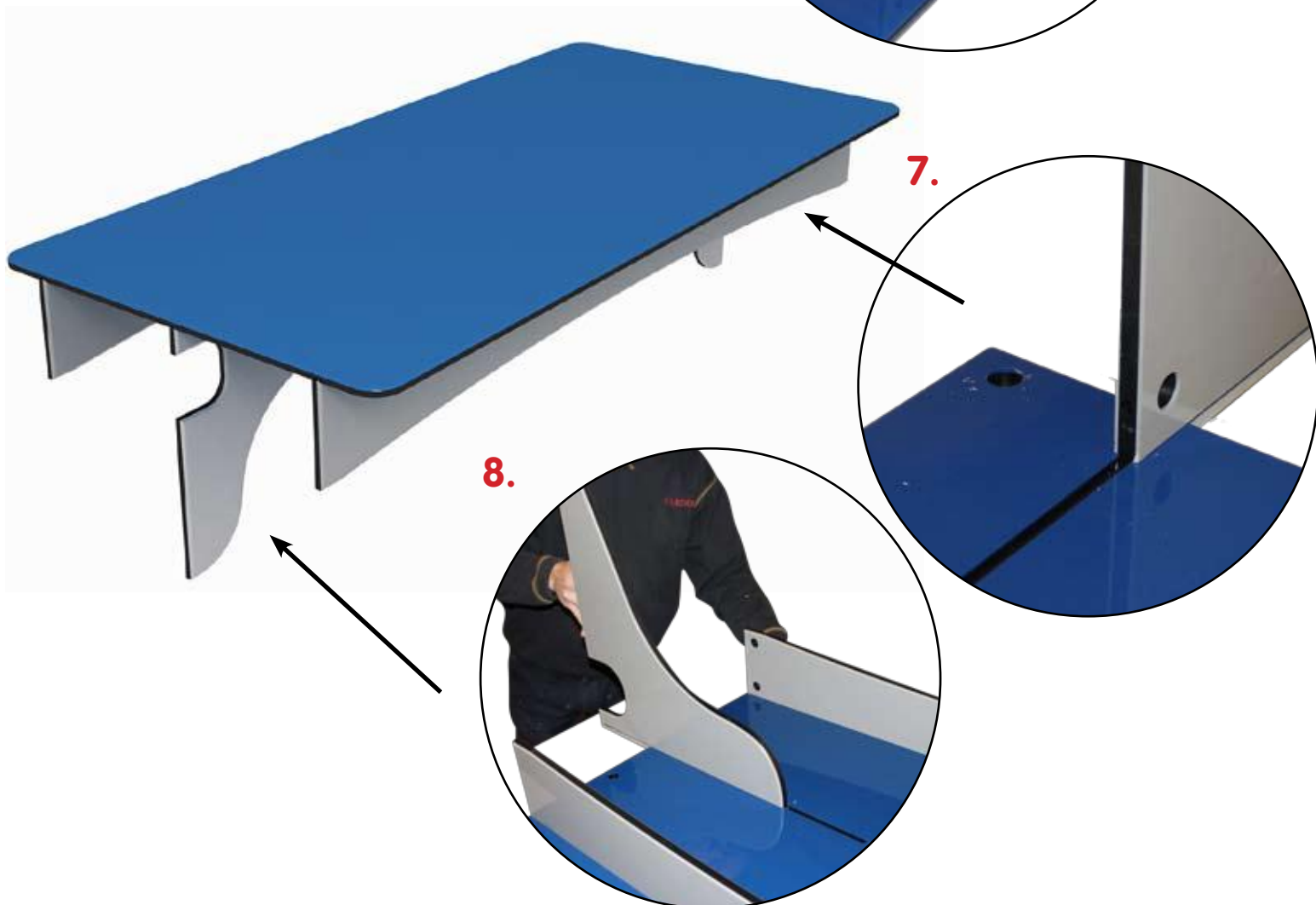
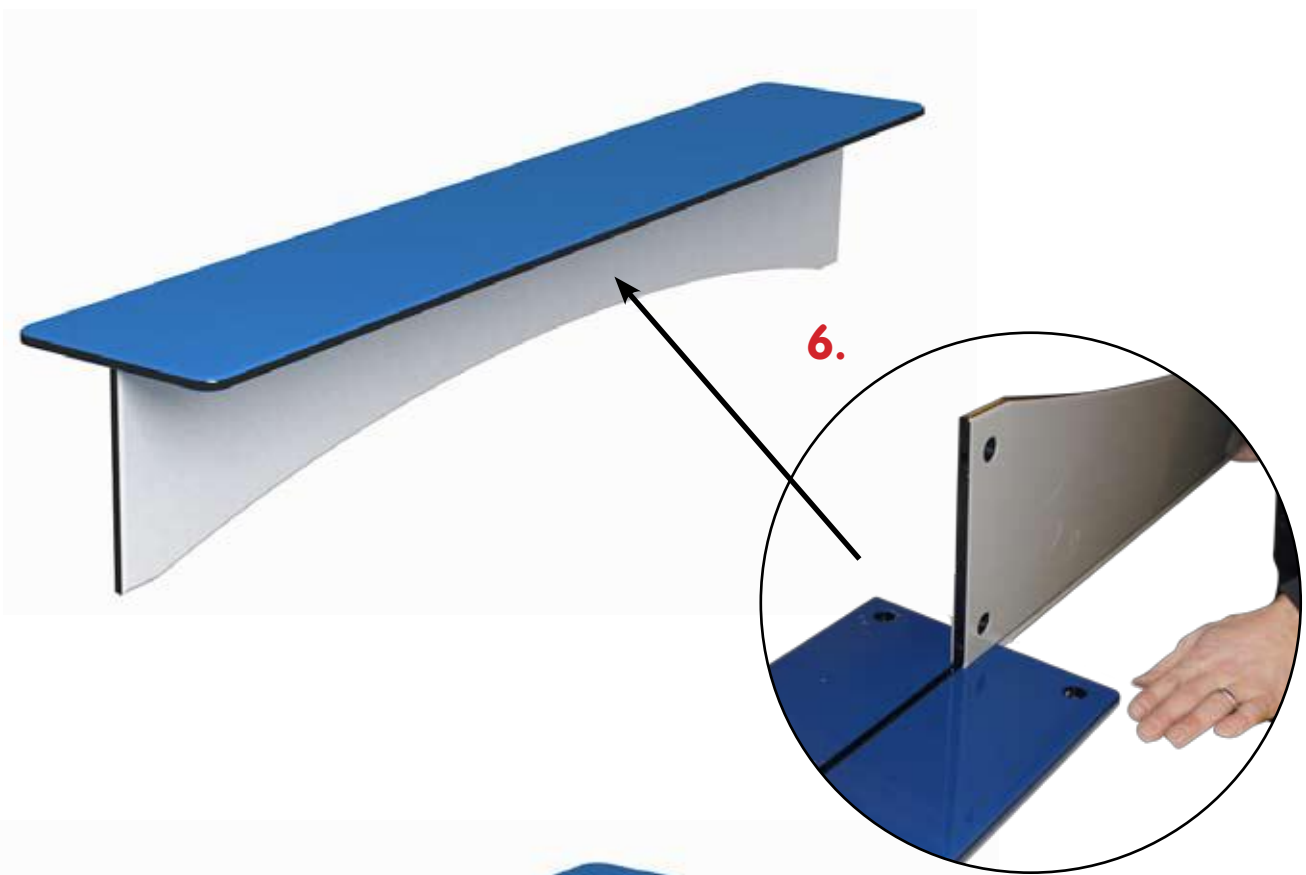

Montage 4 • Assembly 4 • Montage 4 • Assemblage 4 • Asamblaje 4

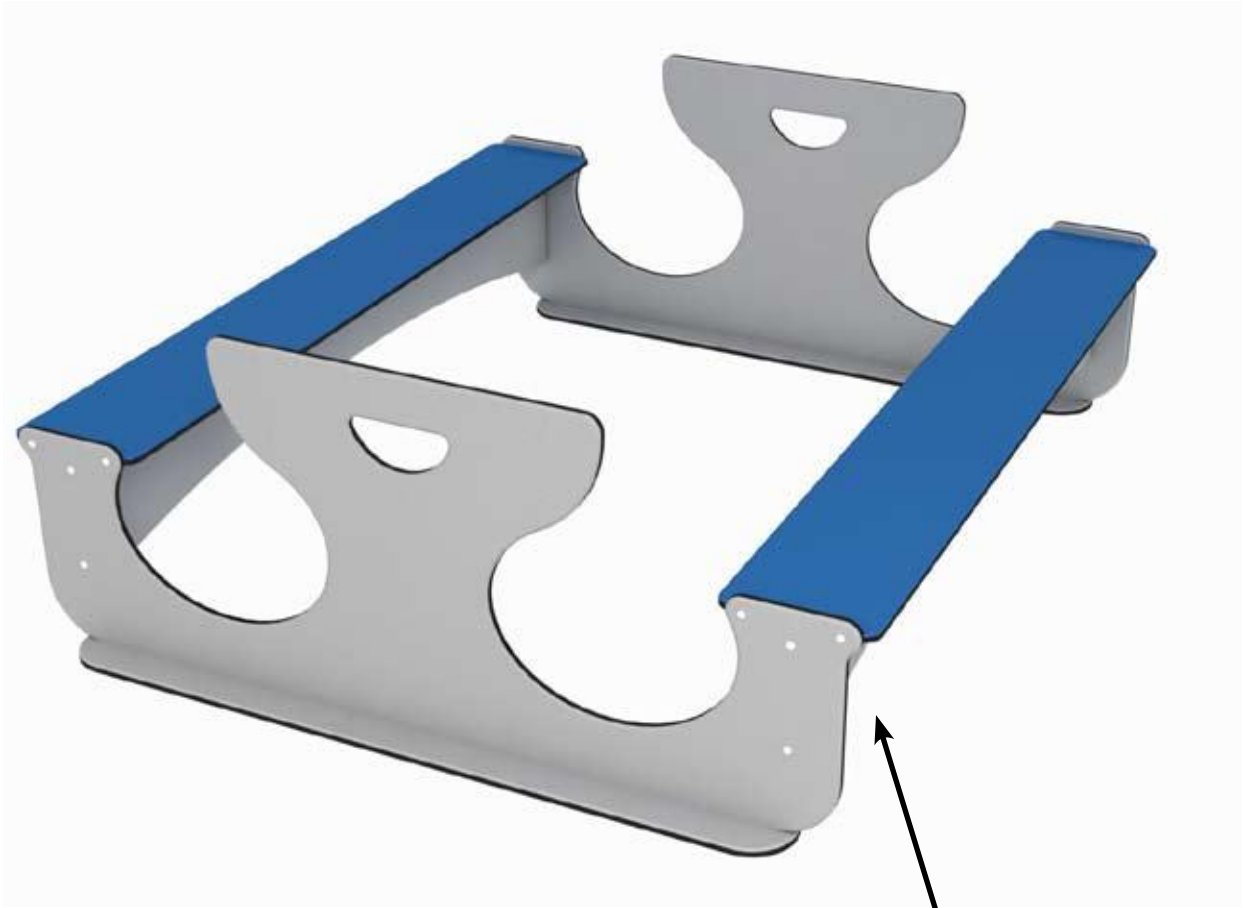

9.



8 X 45 mm

10.



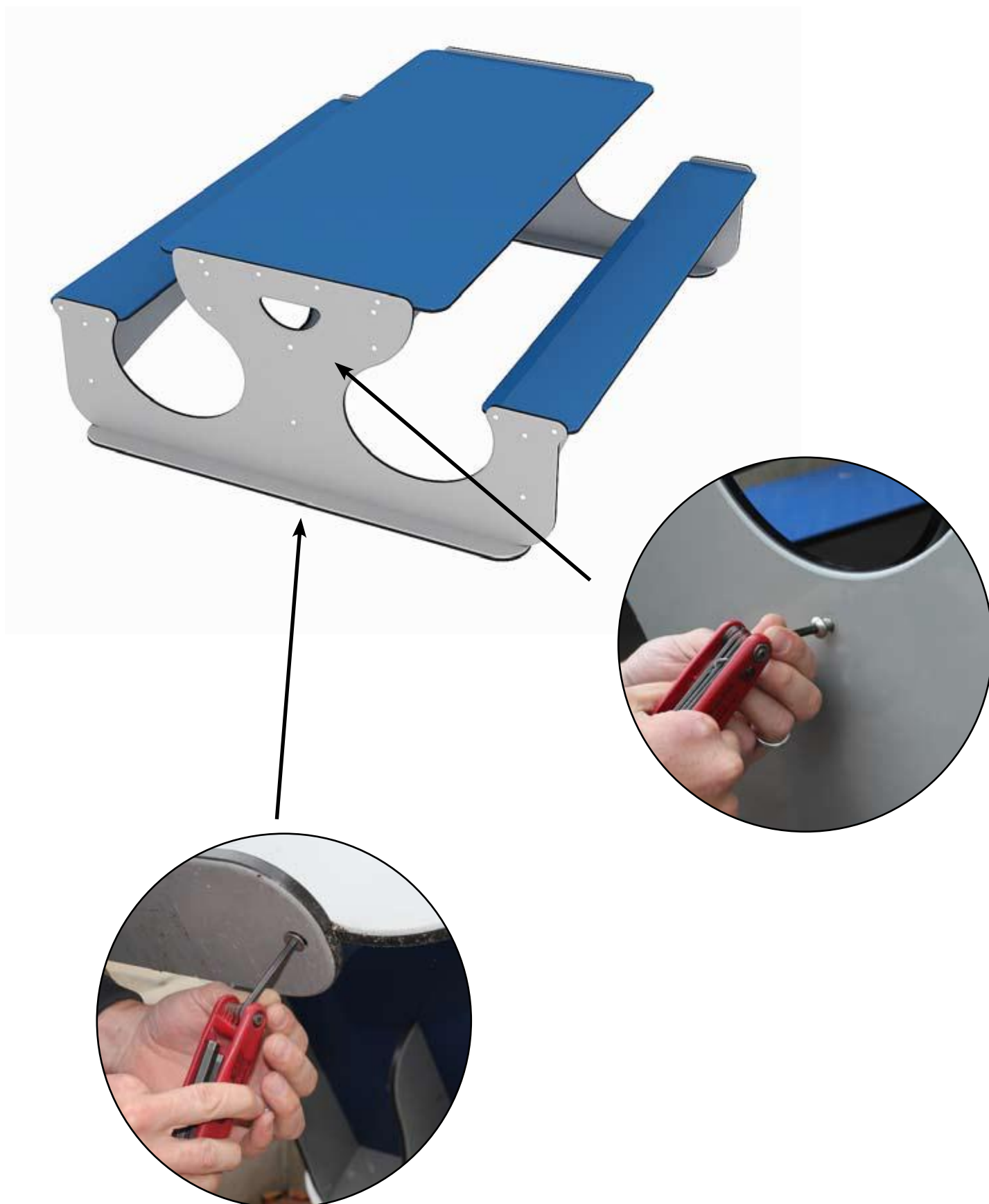

Finish • Finish • Finish • Fin du montage • Finalizar

